



2023 Holiday Activity Book



Holiday Crossword

Word Bank: Present, Wrapping Paper, Lights, Fruit Cake, Candy Cane, Stocking, Santa, Ornament, Halls, Rudolph, Pear tree

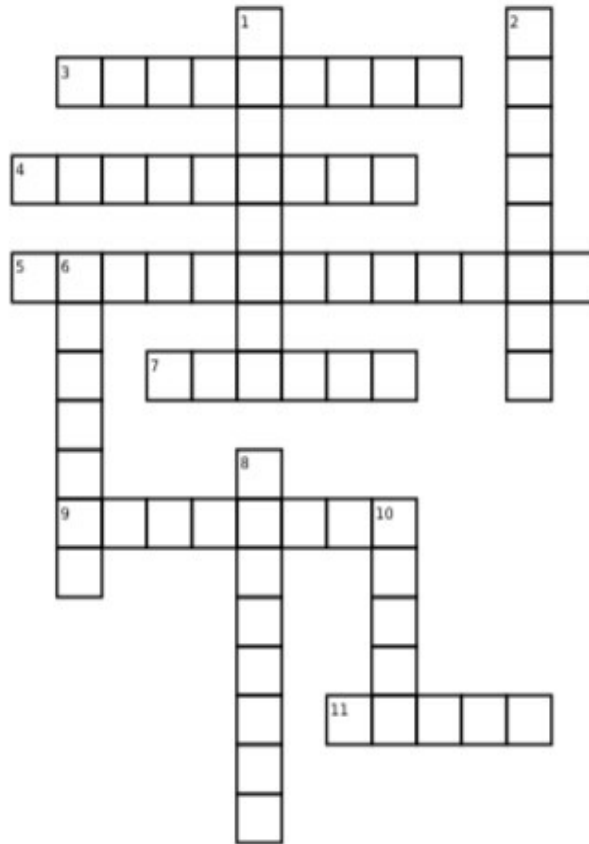

Down:

1. A large sock filled with goodies
2. Something you hang on the tree
6. Has a very shiny nose
8. three French hens, two turtle doves and a partridge in a
10. Father Christmas

Across:

3. A holiday dessert made with dried fruits and nuts
4. Red and white treats
5. What you use to wrap presents
7. Twinkling ___ at night
9. Things you get on Christmas
11. Deck the ____





Help Sort the Holiday Waste

Draw a line from each item to the proper bin. Colour in the pictures.

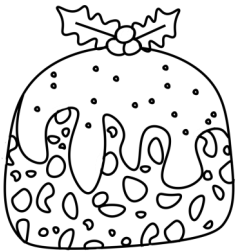

Fruit cake



Drink carton

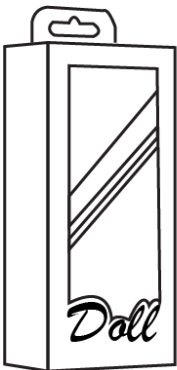

Toy box

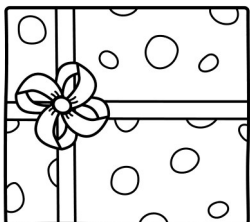

Wrapping paper

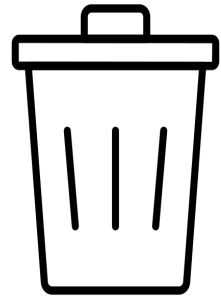

Garbage

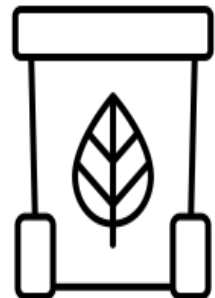

Organic Bin



Recycling Bin

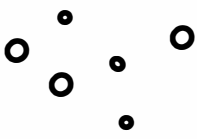
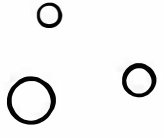
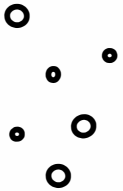
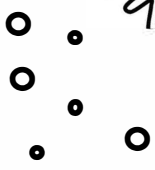
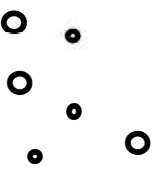
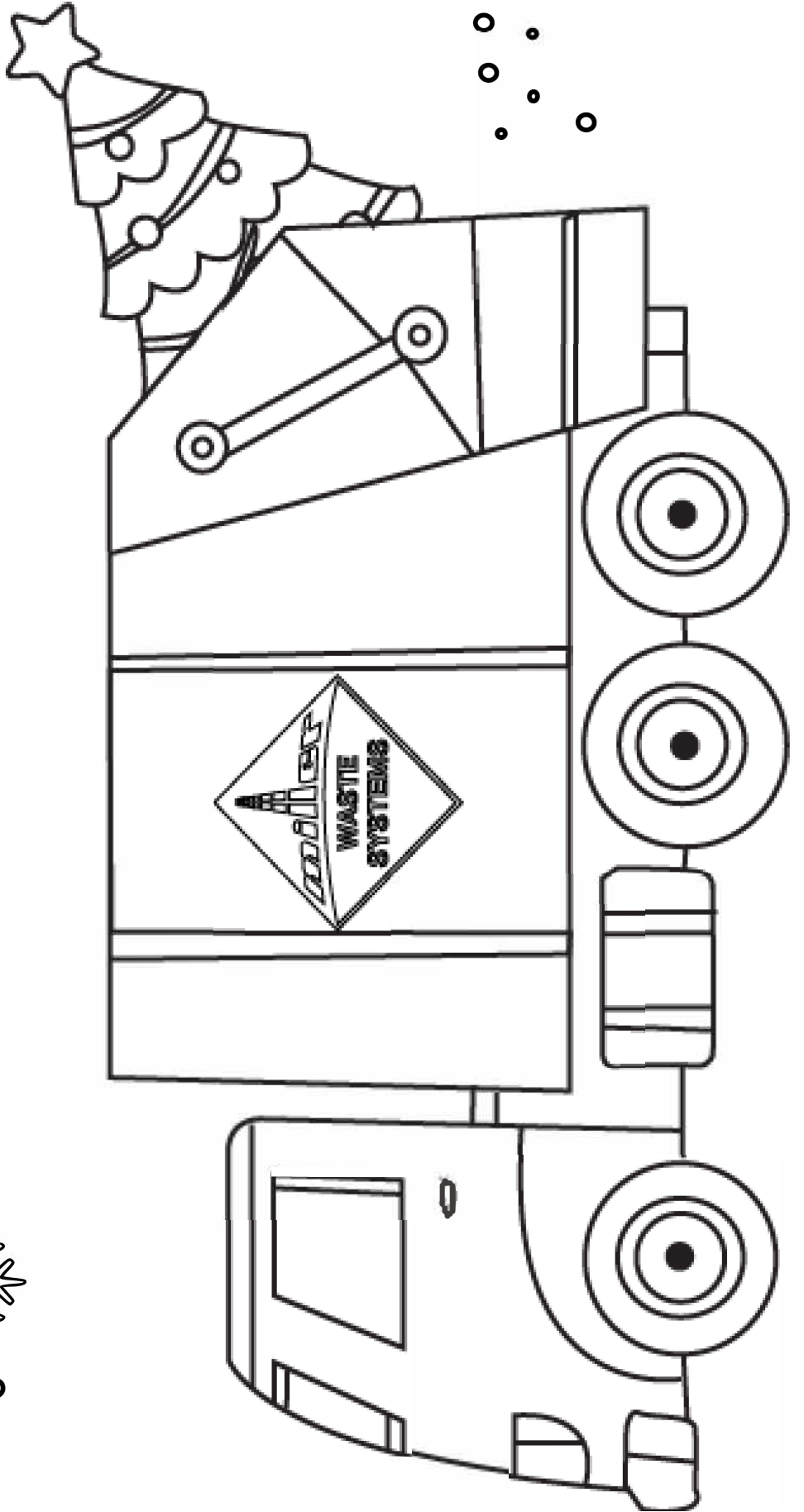
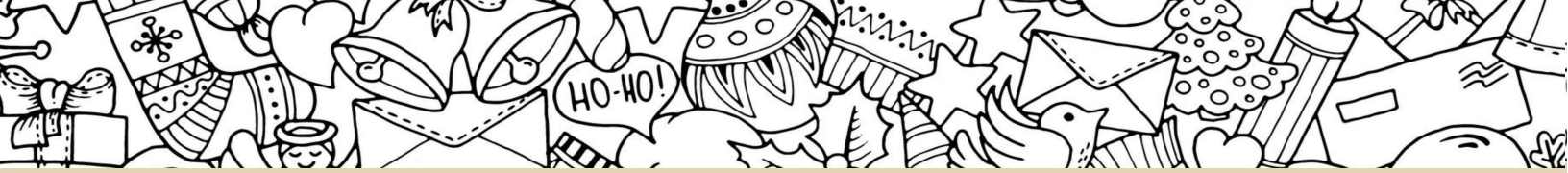



Maze

Help the lost garbage truck! Draw a path the garbage truck can take to get to the Recycling facility.

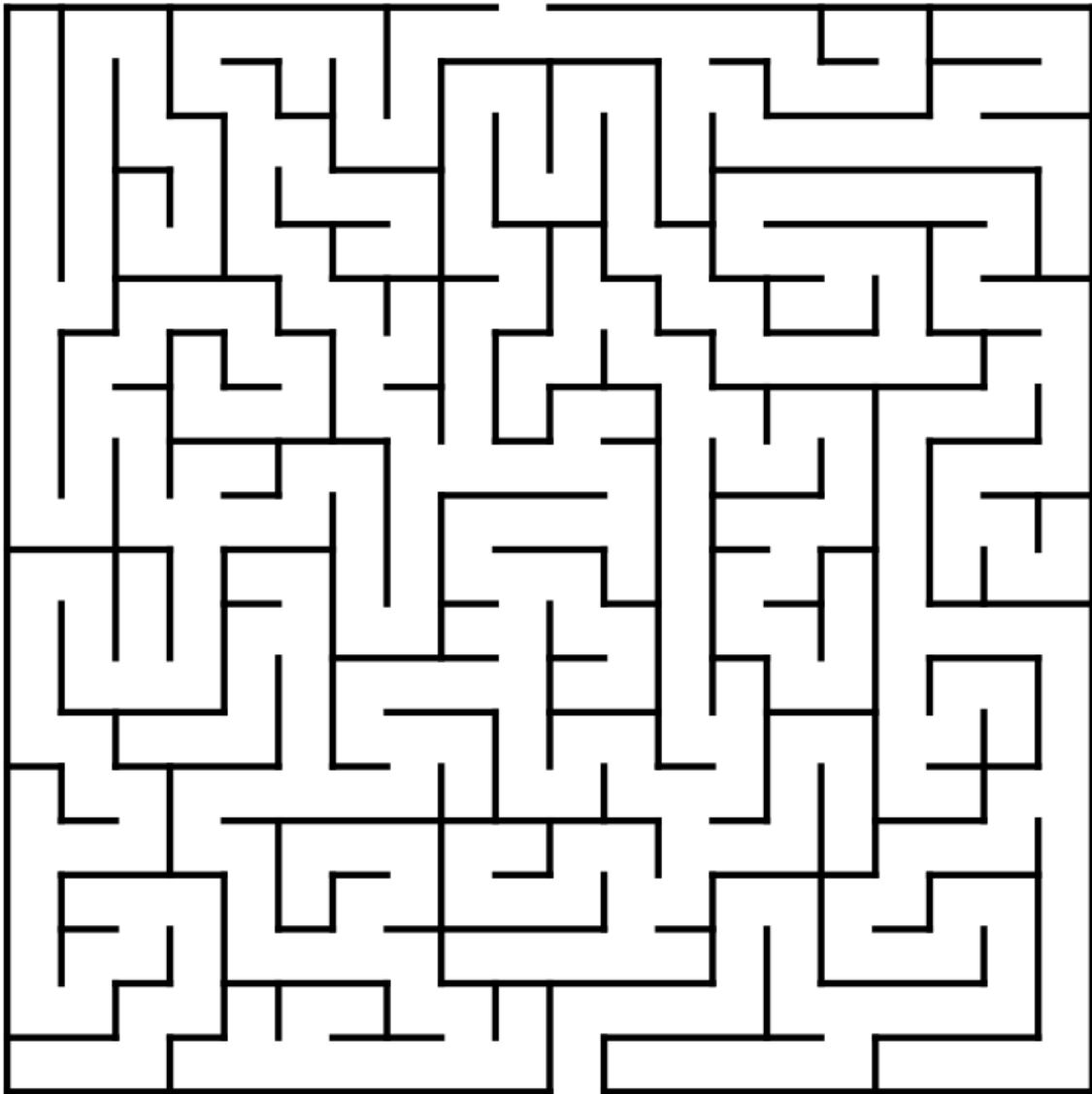



Connect the Dots

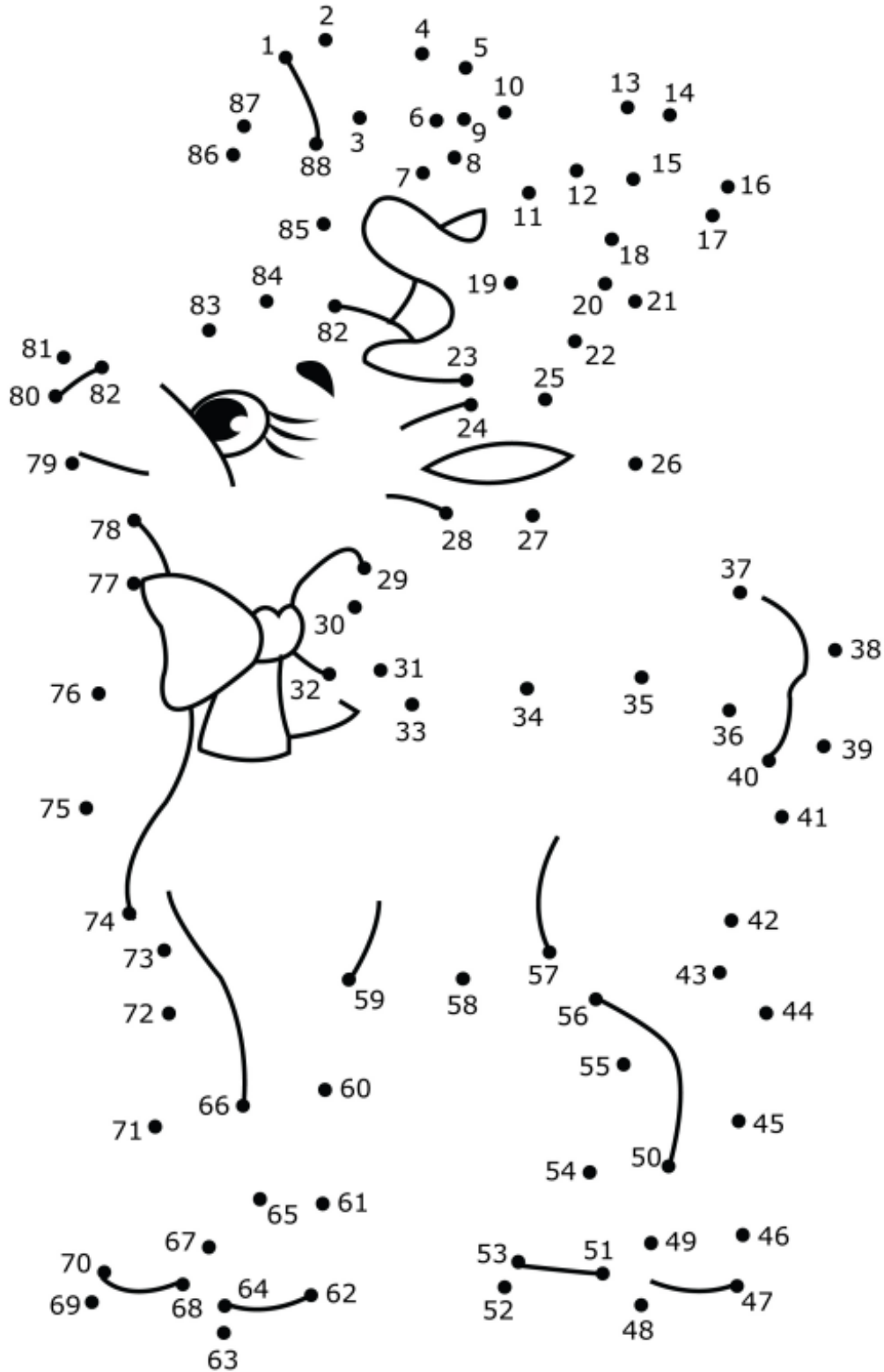



Miller Waste wishes you a wonderful holiday and happy new year!

It's a pleasure to serve our communities and our front-line staff appreciate the support we receive from waste management enthusiasts of all ages!

If you have a photo or story you'd like to share about your kids' experience with Miller Waste, please add #MillerWaste to your Facebook or Instagram post!

Also, be sure to follow our website and social media channels for waste management resources and news about community events.

 miller_waste

 millerwastesi

 miller-waste-systems

 millerwaste.ca

Crossword Solution

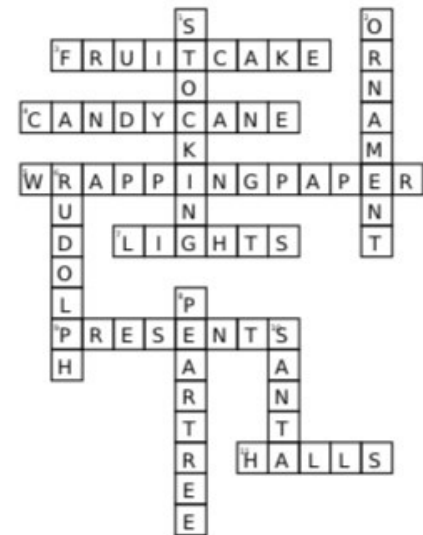

Maze Solution

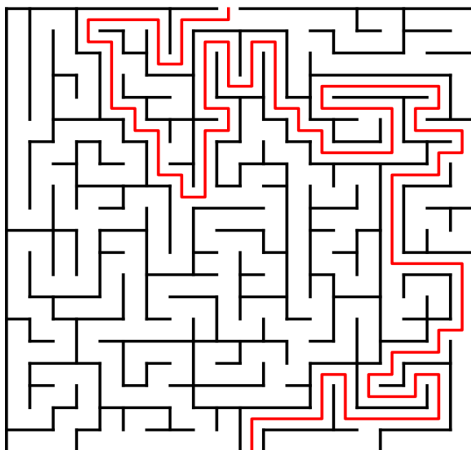

Sorting Solution

